

**ENSTO****Saves Your Energy****NOTICE D'INSTALLATION  
INSTALLATION INSTRUCTION  
PROSPECTO DE INSTALACION**

Série PK FR

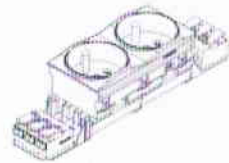

Série PK45 Schuco

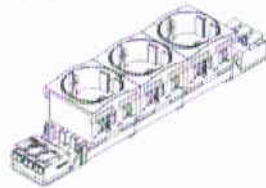
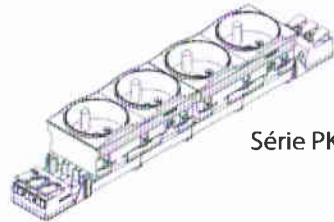

Série PK45 Mixte

Série PKS :

Série PK :



- Socle de prise est conforme à la norme: NFC 61.314  
 La base de la toma es conforme a la norma: IEC 60884-1  
 Base of Klé@ socket is in conformity with the standard: NFC 61,314

**BLOC DE PRISE KLé@, KLé@ DETROMPE ET KLé@ MIXTE**  
**BLOQUE DE TOMA KLé@, KLé@ CORRIENTE PROTEJIDA, KLé@ MIXTO CLIPAJE 45**  
**BASE OF KLé@ SOCKET, KLé@ DATA SOCKET AND KLé@ MIXT CLIP ON 45**

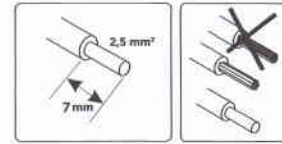
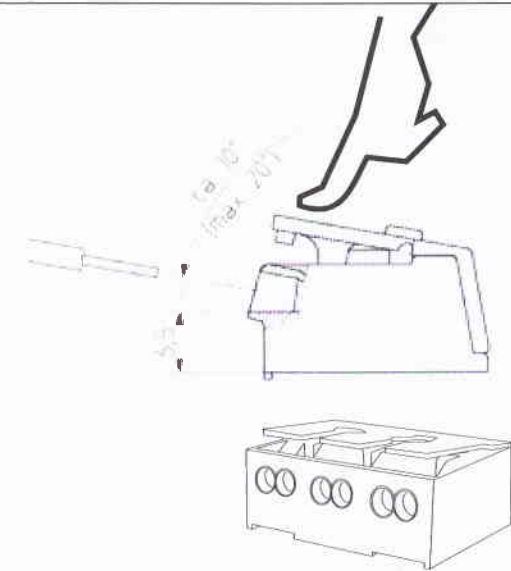

La connexion / La conexión / The connection

**Diamètre du câble:**Externe: 2x0.5 - 2.5 mm<sup>2</sup> réalisation facile**Cable diameters:**External: 2x0.5 - 2.5 mm<sup>2</sup> release facility**Diametro del cable**Externo: 2x0.5 - 2.5 mm<sup>2</sup> realización facil**(FR) SPECIFICATIONS TECHNIQUES**

|                         |       |
|-------------------------|-------|
| Courant nominal (A):    | 16 A  |
| Puissance nominale (W): | 3680W |
| Tension nominale (V):   | 250V  |
| Tension réseau (V):     | 230V  |
| Protection:             | IP20  |

**(GB) TECHNICAL SPECIFICATIONS**

|                         |       |
|-------------------------|-------|
| Rated current (A):      | 16 A  |
| Rated load (W):         | 3680W |
| Rated voltage (V):      | 250V  |
| House hold voltage (V): | 230V  |
| Protection              | IP20  |

**(ESP) PRESCRIPCIONES TÉCNICAS**

|                        |       |
|------------------------|-------|
| Couriente nominal (A): | 16 A  |
| Potencia nominal (W):  | 3680W |
| Tensión nominal (V):   | 250V  |
| Tensión de la red (V): | 230V  |
| Protección:            | IP20  |



Introduction dans une plinthe ou une colonne  
Introducción en un zócalo o una columna  
Introduction into a trunk or a column

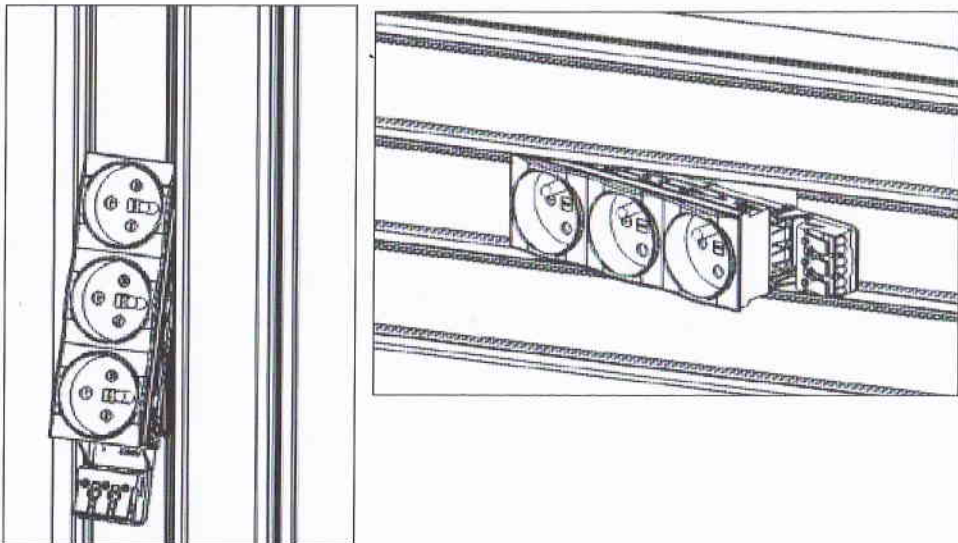

Attention / Atención / Attention



La manipulation involontaire des leviers peut entraîner la déconnexion des fils du pré-cablage

La manipulación involuntaria de las palancas puede implicar la desconexión de los hijos del pré-cablaje

The involuntary handling of the levers can involve the disconnection of the wiring !!

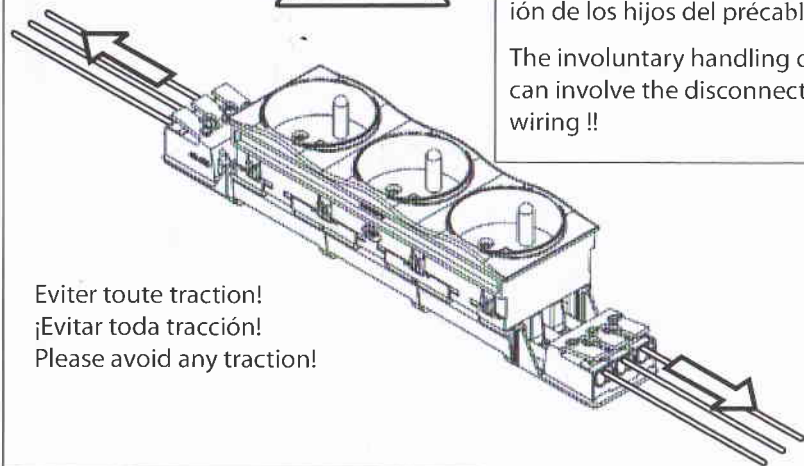

Eviter toute traction!  
¡Evitar toda tracción!  
Please avoid any traction!

ENSTO INDUSTRIE SAS

R.D 916  
66170 NEFIACH  
TEL + 00 33 (0)4 68 57 20 20  
FAX + 00 33 (0)4 68 57 30 30  
[www.ensto.com](http://www.ensto.com)

SAS au capital social de 305440€  
SIREN 327 919 452  
TVA FR82 327 919 452