

ENSTO

Saves Your Energy

NOTICE D'INSTALLATION
INSTALLATION INSTRUCTION
PROSPECTO DE INSTALACION

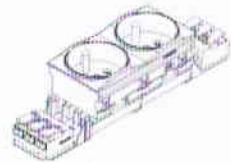

Série PK FR

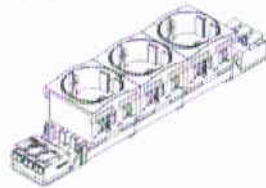

Série PK45 Schuco

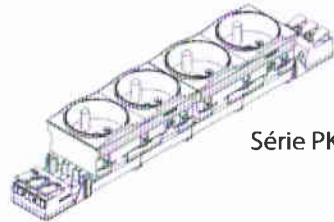

Série PK45 Mixte

Série PKS :

Série PK :



- Socle de prise est conforme à la norme: NFC 61.314
La base de la toma es conforme a la norma: IEC 60884-1
Base of Klé@ socket is in conformity with the standard: NFC 61,314

BLOC DE PRISE KLé@, KLé@ DETROMPE ET KLé@ MIXTE
BLOQUE DE TOMA KLé@, KLé@ CORRIENTE PROTEJIDA, KLé@ MIXTO CLIPAJE 45
BASE OF KLé@ SOCKET, KLé@ DATA SOCKET AND KLé@ MIXT CLIP ON 45



Reference: NO 5200

La connexion / La conexión / The connection

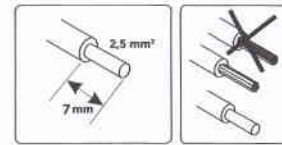

Diamètre du câble:
Externe: 2x0.5 - 2.5 mm² réalisation facile

Cable diameters:
External: 2x0.5 - 2.5 mm² release facility

Diametro del cable
Externo: 2x0.5 - 2.5 mm² realización facil

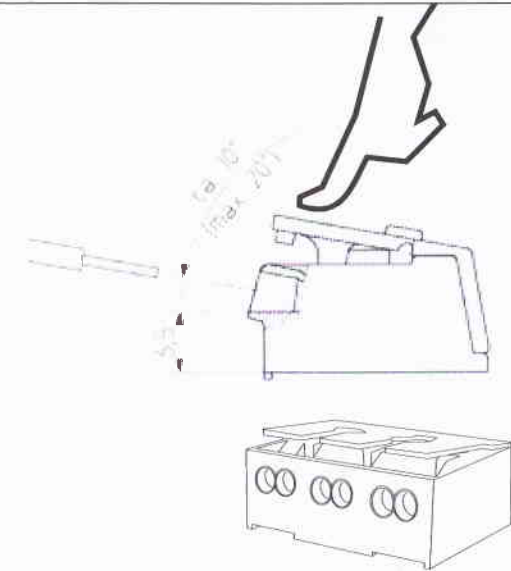

(FR) SPECIFICATIONS TECHNIQUES

Courant nominal (A): 16 A
Puissance nominale (W): 3680W
Tension nominale (V): 250V
Tension réseau (V): 230V
Protection: IP20

(GB) TECHNICAL SPECIFICATIONS

Rated current (A): 16 A
Rated load (W): 3680W
Rated voltage (V): 250V
House hold voltage (V): 230V
Protection: IP20

(ESP) PRESCRIPCIONES TÉCNICAS

Couriente nominal (A): 16 A
Potencia nominal (W): 3680W
Tensión nominal (V): 250V
Tensión de la red (V): 230V
Protección: IP20

Introduction dans une plinthe ou une colonne
Introducción en un zócalo o una columna
Introduction into a trunk or a column

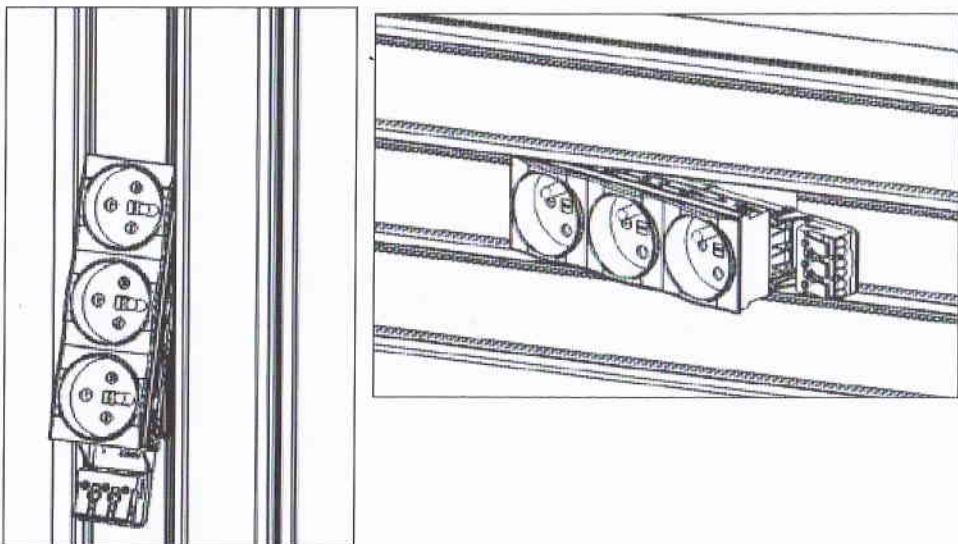

Attention / Atención / Attention



La manipulation involontaire des leviers peut entraîner la déconnexion des fils du pré-cablage

La manipulación involuntaria de las palancas puede implicar la desconexión de los hijos del pré-cablaje

The involuntary handling of the levers can involve the disconnection of the wiring !!

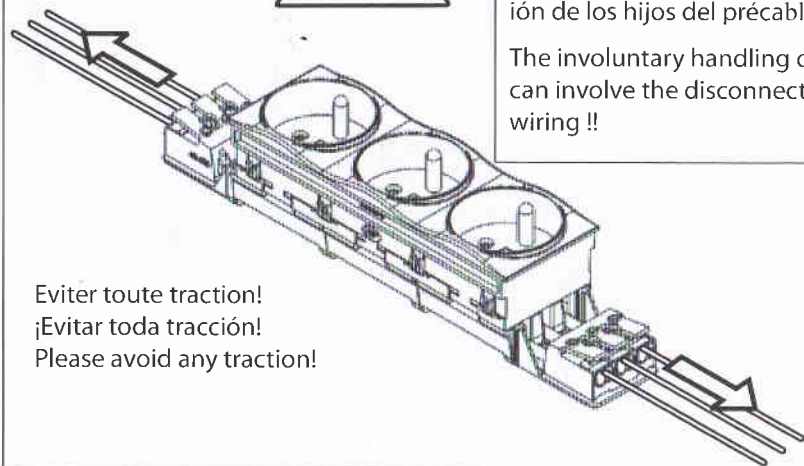

Eviter toute traction!
¡Evitar toda tracción!
Please avoid any traction!

ENSTO INDUSTRIE SAS

R.D 916
66170 NEFIACH
TEL + 00 33 (0)4 68 57 20 20
FAX + 00 33 (0)4 68 57 30 30
www.ensto.com

SAS au capital social de 305440€
SIREN 327 919 452
TVA FR82 327 919 452